

LD38 RGBW



Exterior High Power Linear Lensed LED Surface Grazer and Flood Light

Data sheet - Page 1



Design: Light + Design Project: The Lansdown Club Product: LD38

LD38 RGBW is an exterior rated, high power surface grazer that offers superb continuous wall washing and colour mix capabilities. The 4 die RGBW LED is placed under a single 60deg colour mix optic, which allows mixing at source with no coloured shadows. It offers great flexibility to the designer with a range of options that suit most design details and applications; available in custom lengths up to 975mm; RGB and RGBW colour mix options; various mounting options, finishes and accessories. These coupled with the latest in LED technology make LD38 the perfect choice for illuminating an entire external project.

Key Features

- Single colour mix optic for very effective near field colour mixing
- Uses the latest in LED technology with an RGBW LED mixing at source
- White LED is 4000K
- Superb continuous wall washing capabilities
- Very high power for surface grazing or flood lighting
- Compact, minimal design
- LED spacing of 75mm
- Spacing is maintained across multiple lengths, so no dark spots!
- Wide range of fixing options
- Short pieces can be made interlinked to accommodate curves
- Lengths are custom made to suit to a maximum of 975mm
- Available with Switched, 0-10V, DMX or Dali drivers

Specification

Applications	
Beam Angles	60°
LED type	Cree XML RGBW
Colour temperature	RGB or RGBW

Drive Current (mA)	350					
LED power* (W)	(RGB) 3.6W or (RGBW) 4.8W					
LED Colour	Red	Blue	Green	White (4000K)	Total RGB	Total RGBW
Forward voltage (V) ₁₀₀	2.1V	2.9V	3.1V	3.0V	8.1V	11.1
LED power W/m (13 LEDs)	11.2W	15.2W	16W	15.2W	42.4W	57.6W
Lumen output lm/m (L ₁₀₀)	534	168	860	845	1571	2416**

Drive Current (mA)	500					
LED power* (W)	(RGB) 5.1W or (RGBW) 6.8W					
LED Colour	Red	Blue	Green	White (4000K)	Total RGB	Total RGBW
Forward voltage (V) ₁₀₀	2.3V	3V	3.2V	2.9V	8.5V	11.4
LED power W/m (13 LEDs)	16.8	22.4	23.8	21.7	63	84.7
Lumen output lm/m (L ₁₀₀)	754	224	1079	1131	2057	3188

LED lifetime (to 70% lumen maintenance) 50,000hrs at a max ambient temperature of 45°C

Materials Silver or black anodised aluminium body & end caps, black & optically clear resin

Wiring Comes pre-wired with 2m lead, can be specified with up to 10m at extra cost

IP rating IP67

* LED watts allows for 85% efficient driver

** (RGBW) White channel should be run separate from RGB channels

Please note this table is based on 75mm LED spacing

Ambient Temperature Considerations

See table below to determine which output and colour type best suits the intended environment.

Product codes	RGB	RGBW	RGB or W*
LD38-350	45°C	45°C	45°C
LD38-500	45°C	35°C	45°C

* These must be treated separately. Either the RGB or White channels can be in use but not all at the same time.

LD38 RGBW



Exterior High Power Linear Lensed LED Surface Grazer and Flood Light

Data sheet - Page 2

Made to measure

Custom made lengths as standard allow the designer to specify exactly the length they require. Spacing is maintained across multiple lengths, so no dark spots!

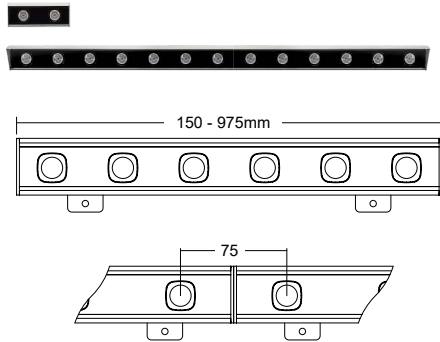

Finishes and materials

LD38 has been designed for extreme environments, so only high quality materials and finishes are used to ensure long lasting reliability. Silver or black anodised is to a minimum thickness of 25 microns which offers high protection in all external environments. RAL external paint finishes are also available and allow the LD38 to blend into the surrounding architecture.

/Silver anodised



/Black anodised



/Paint finish RAL



LD38 RGBW



Exterior High Power Linear Lensed LED Surface Grazer and Flood Light

Data sheet - Page 3

Fixing Options and Dimensions

/ABM

Surface Adjustable Bracket Mounting

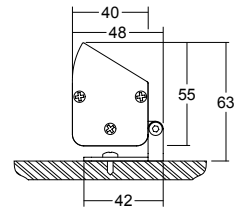
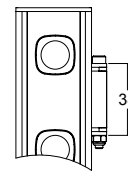
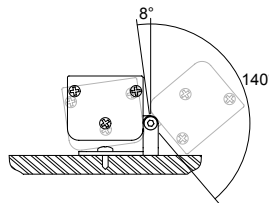
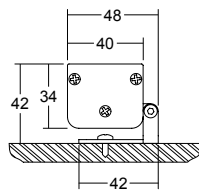

/BSM

Bracket Side Mounting

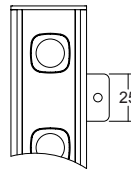
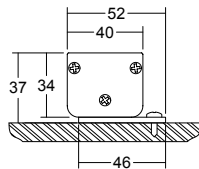

/AWB-50

Adjustable Wall Bracket 50mm

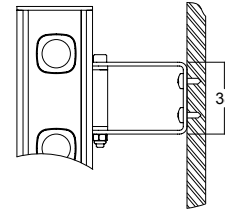
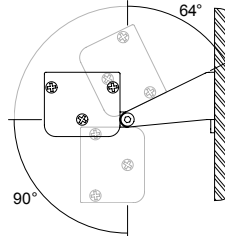
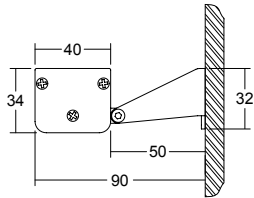

/AWB-300

Adjustable Wall Bracket 300mm
(for custom dimensions please contact us)

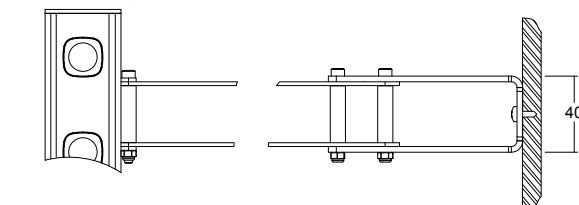
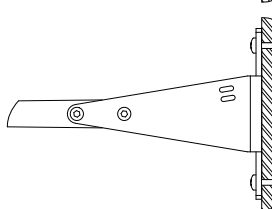
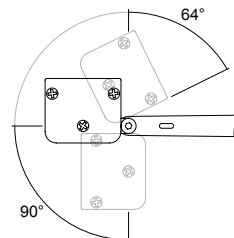
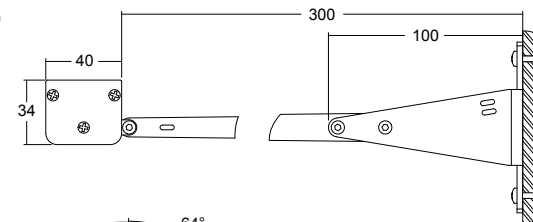

LD38 RGBW

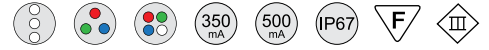

Exterior High Power Linear Lensed LED Surface Grazer and Flood Light

Data sheet - Page 4

Fixing Options and Dimensions

/GS

The ground spike accessory enables the use of the LD38 as an innovative alternative to conventional spotlights. It offers linear lighting to a range of landscape and garden lighting effects. Ideal for lighting hedge rows, walls and short pieces to light around trees. It can be specified with wider LED spacing to suit the budget or light output needed.

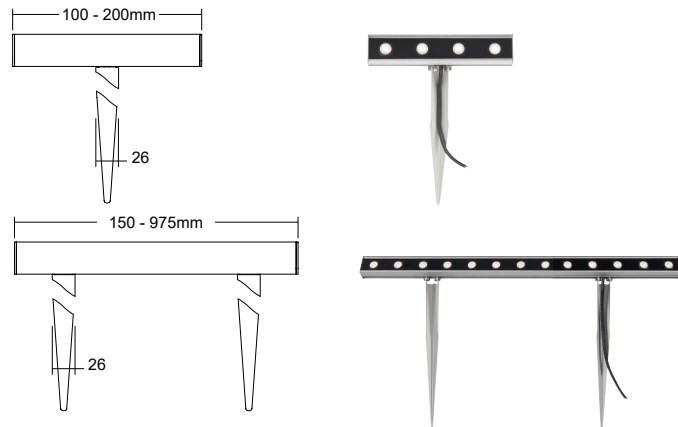

LD38 RGBW



Exterior High Power Linear Lensed LED Surface Grazer and Flood Light

Data sheet - Page 5

Applications and Mounting Option Guide

LD38 is incredibly versatile, allowing it to be used to illuminate an entire external project. From high power wall grazing, window reveals, floodlighting and landscape illumination there is a fixing accessory and specification to suit. The made to measure lengths allow the designer to create the exact effect they want to achieve in a particular detail. If we don't have the fixing/accessory you want please get in touch.

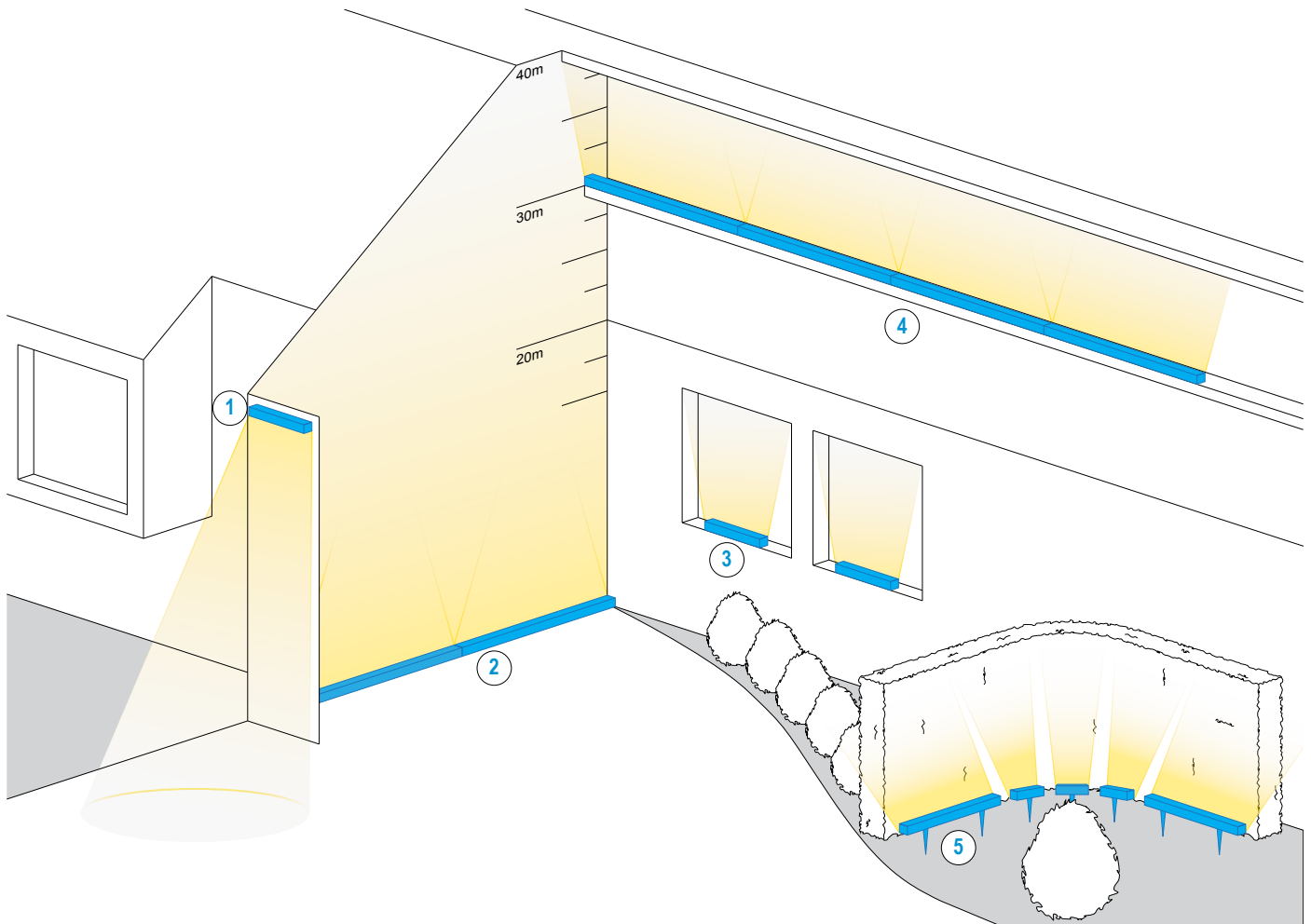

Mounting options:

1

/AWB-50



/AWB-300



2

/AWB-50



/AWB-300



3

/ABM



/BSM



4

/ABM



/BSM



5

/GS



LD38 RGBW

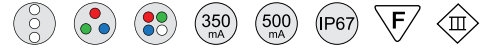

Exterior High Power Linear Lensed LED Surface Grazer and Flood Light

Data sheet - Page 6

Accessories

/GL

Anti glare louvre. Please note this is always supplied in black finish, and is supplied as standard with the louvre positioned to reduce glare when looking at the lit surface. The GLF orientation is useful for applications where the LD38 is placed on a window ledge and reduced glare is required from inside the building looking out.



/GL

Standard orientation of smart louvre

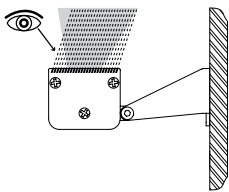

/GLF

Orientation available on request

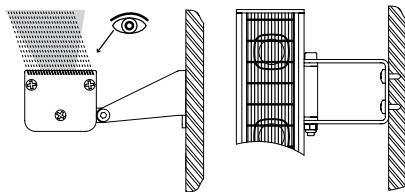

/CO

Linear anti-glare cowl, comes with raised end caps to also reduce glare to the sides

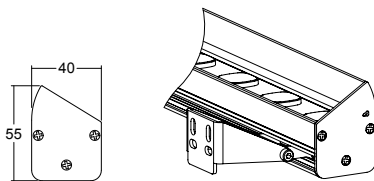

Photometrics

Photometric files are included in the design pack which can be downloaded from the LD38 product page on the website.

Order Codes and Options

Product code	LED spacing	Beam angle	Fitting colour	Fixing option	Accessory	Length
LD38-RGB -RGBW	<input type="text"/>	<input type="text"/>	<input type="text"/>	<input type="text"/>	<input type="text"/>	<input type="text"/>

Example: LD38 RGBW-500 / 75 / WB / White / AWB-50 / CO / 975mm

Product codes with output options

RGB	LD38 RGB-350 - 1.2W (3.6W)	RGBW	LD38 RGBW-350 - 1.2W (4.8W)
	LD38 RGB-500 - 1.7W (5.1W)		LD38 RGBW-500 - 1.7W (6.8W)

LED spacing

75mm	/75
------	-----

Beam / lens angle options

60° wide	/WB
----------	-----

Product colour

- Silver - End caps, extrusion and fixings (silver anodised)
- Black - End caps, extrusion and fixings (black powder coat)
- White or RAL - End caps, extrusion and fixings (paint finish)

Fixing options

Adjustable wall bracket (50mm)	/AWB-50
Adjustable wall bracket (300mm)	/AWB-300
Surface mounted bracket	/ABM
Bracket side mounting	/BSM
Ground spike	/GS

Accessory

Linear anti glare cowl	/CO
Anti glare louvre	/GL
Anti glare louvre (front facing)	/GLF

Use with 350mA constant current LED drivers

DMX dimmable driver use our TXDEL4A350DMX to run 975mm length (13 LEDs)
DALI dimmable driver use our TXDEL4A350DALI to run 975mm length (13 LEDs)
Please see the downloads section on our website.